

PIIM PV 400 DS Vseries

- Surge arresters type T2 intended for photovoltaic systems (PV).
- Products are designed in a Y-type connection, which is resistant to earth faults of working conductors.
- Particular varistor sectors, connected between the terminals L+, L- and PE are equipped with internal disconnectors, which are activated when the varistors fail (overheat) and they are able to interrupt the DC current.
- Special construction of the internal disconnector allows installation without a back-up fuse.
- They are installed in PV applications without an external LPS or with an external LPS, where the sufficient distance "s" is observed.
- Suitable for all LPL levels.
- Ensure the equipotential bonding of positive and negative busbars of PV systems and the elimination of transient overvoltage that originates during the atmospheric discharges or switching processes.
- **M** indication specifies a type of construction with removable module.
- **DS** indication specifies a version with remote monitoring.

Type	PIIM PV 400 DS Vseries	
Test class according to EN 61643-11:2012 and EN 61643-31:2019		T2
System		DC
PV system type		Ungrounded
SPD connection type		Y
Maximum continuous operating voltage (+/-)	U_{CPV}	420 V DC
Maximum continuous operating voltage (\pm /PE)	U_{CPV}	420 V DC
Max. voltage of PV generator $U_{OCSTC} \leq U_{CPV} / 1.2$	U_{OCSTC}	350 V
Short-circuit current rating	I_{SCPV}	10 kA
Maximum discharge current (8/20)	I_{max}	40 kA
Nominal discharge current for class II test (8/20)	I_n	15 kA
Voltage protection level at I_n	U_p	< 1.6 kV
Response time	t_A	< 25 ns
Housing material		Polyamid PA6, UL94 V-0
Degree of protection		IP20
Operating temperature	ϑ	-40 ÷ 70 °C
Humidity range	RH	5 ÷ 95 %
Minimum cross-section of connected Cu conductors according to IEC 61643-32:2017 (doesn't apply to „V“ connection) for T2	S	2.5 mm ² (L+, L-) 6 mm ² (PE)
Clamp fastening range (solid conductor)		2.5 ÷ 35 mm ²
Clamp fastening range (stranded conductor)		2.5 ÷ 25 mm ²
Tightening moment		4 Nm
Installation		On DIN rail 35 mm
Modular width		3 TE
Operating position		Any
Product placement environment		Internal
SPD failure mode		OCFM

Type	PIIIM PV 400 DS Vseries	
Signalling at the device	Optic	
Importance of local signaling	OK – green target FAULT – red target	
Remote signalling	Yes	
Potential free signal contact (S) (recommended cross-section of remote monitoring max. 1 mm ²)	AC: 250 V / 1.5 A, DC: 250 V / 0.1 A	
Modular design	Yes	
Article number of spare module	27 057	
Lifetime	> 100 000 h	
Designed according to standards		
Requirements and test methods for SPDs for photovoltaic installations	IEC 61643-31:2018	
Safety of Flammability of Plastic Materials	UL 94	
Application standards		
Protection against lightning	IEC 62305:2010	
Selection and application principles for SPDs connected to photovoltaic installations	CLC/TS 50539-12:2010	
Low-voltage electrical installations – Photovoltaic (PV) systems	HD 60364-7-712:2016	
Ordering, packaging and additional data		
Mass	m	270 g
Mass (including the packaging)	m	289 g
Packaging dimensions (H x W x D)		60 x 111 x 87 mm
Packaging value	V	0.58 dm ³
ETIM group		EG000021
ETIM class		EC000941
Customs tariff no.		85363010
EAN code		8590681122976
Art. number		27 067



The link in the QR code leads to the online presentation of the PIIIM PV 400 DS Vseries. There, in addition to the always up-to-date data sheet, you will also find all diagrams and drawings, declarations of conformity, or 2D or 3D models and other necessary materials. For more information, visit www.hakil.com



Application wiring diagram (installation)

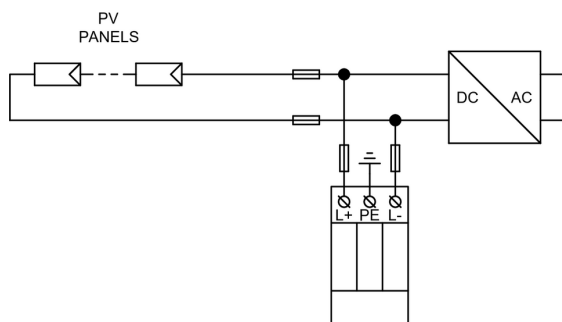

Internal diagram

